

GMXSH Disc Brake Caliper - Spring Applied, Hydraulically Released

Nominal dimensions given
For caliper dimensions see DS2600

Inlet and Bleed ports
G 1/8 (1/8" BSP)

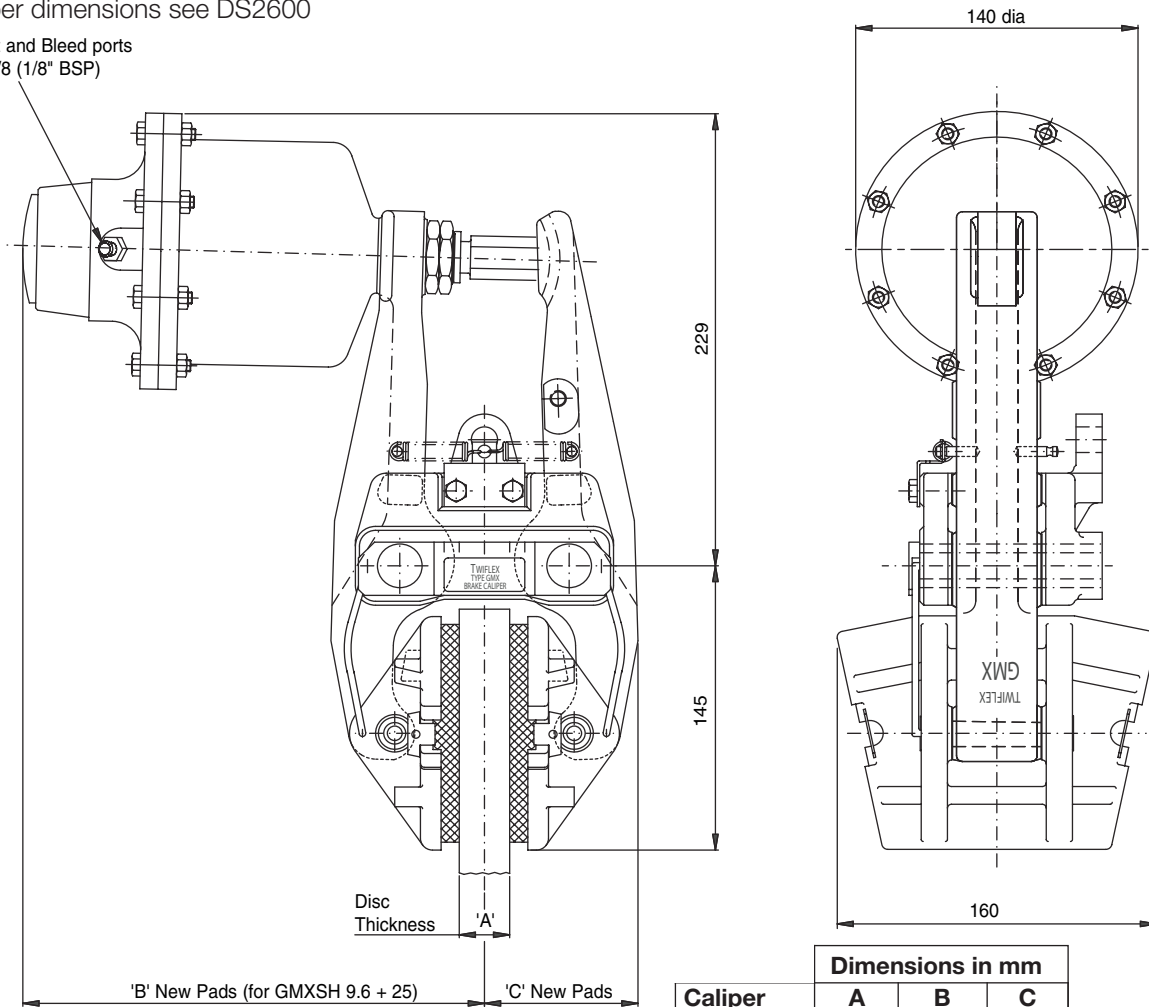

Dimensions in mm			
Caliper	A	B	C
GMXSH 25	25	229	76
GMXSH 30	30	230.6	77.6
GMXSH 40	40	233.9	80.9

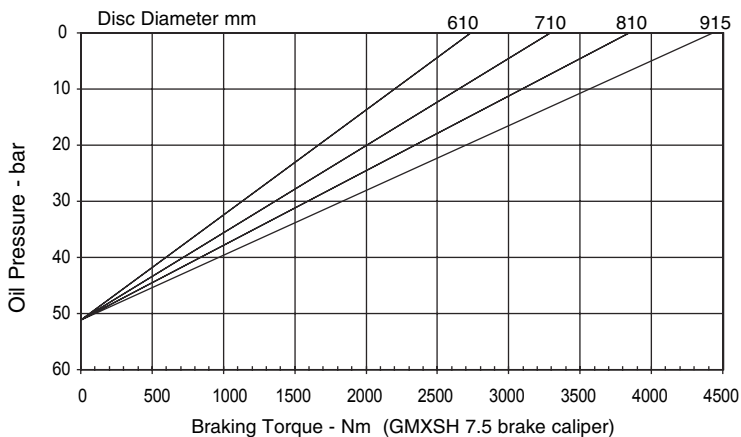

Weight XSH 9.6 caliper and thruster - 13.82kg
XSH 7.5 caliper and thruster - 13.62kg
XSH 4.6 caliper and thruster - 13.22kg
Caliper only - 9.22kg

Volume displacement of thruster at 6mm Retraction is 9.1 ml

Maximum pressure - 120 bar

Thruster	Maximum Braking Force - kN	Minimum Pressure for Full Retraction - bar
XSH 9.6	14.3	82
XSH 7.5	11.2	65
XSH 4.6	6.8	40

The ratings shown on the above graph are based on fully bedded and conditioned brake pads with nominal friction coefficient $\mu = 0.4$.

For bedding-in and conditioning procedures see Publication M1060.

Braking Force is defined as the Tangential Force acting on the brake disc at the Effective Disc Radius.
Braking Torque (Nm) = Braking Force (N) x Effective Disc Radius (m) where Effective Disc Radius = Actual Disc Radius - 0.06.

Twiflex Disc Brakes must be used with Twiflex asbestos free brake pads. The use of any other brake pads will invalidate the warranty. Twiflex Limited reserves the right to modify or change the design without prior notice.

GMXSH Disc Brake Caliper - Spring Applied, Hydraulically Released

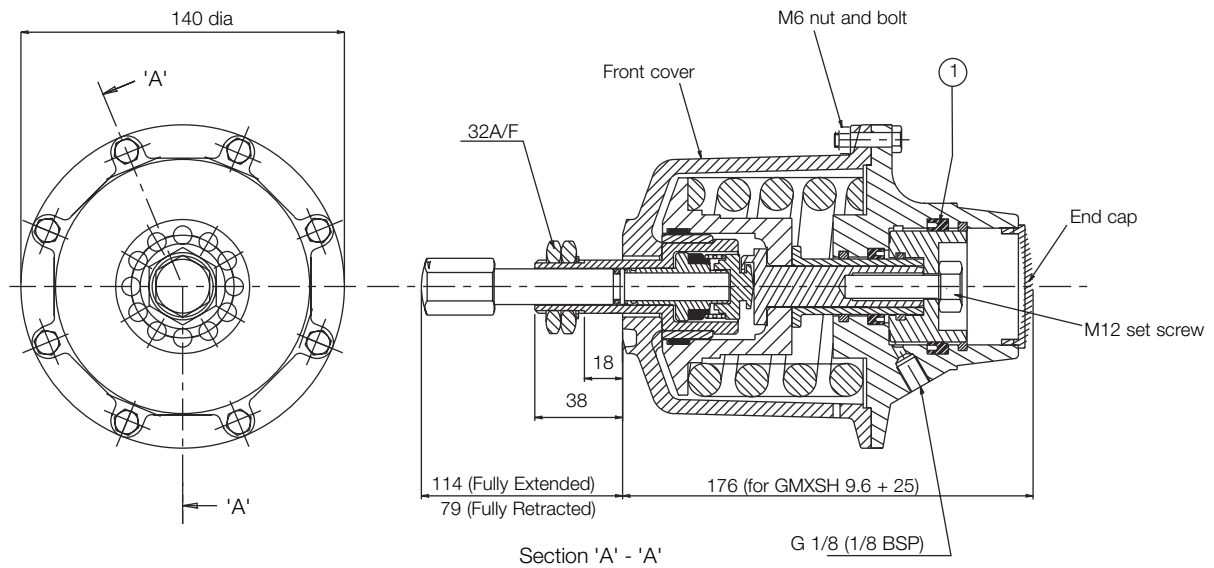

AVAILABLE SPARES		
Item	Component	Part No.
1	Seal Kit	6000356

Thruster Part Number:

XSH 9.6 7500357
 XSH 7.5 7500147
 XSH 4.6 7500163

This thruster requires no routine maintenance but if it becomes necessary to dismantle it for any reason, it is important to remember that it houses a powerful compressed spring.

The sequence in which it is dismantled should be as follows

1. Remove from caliper
2. Unscrew and remove the push rod
3. Remove the 8 - M6 nuts and bolts securing the front cover (see drawing)
4. Remove the complete front cover assembly
5. Remove the M12 set screw (see drawing)

All the internal parts may now be dismantled for inspection or replacement. Re-assembly is carried out by reversing the above sequence.

Tighten torque for the M12 set screw is 80 Nm

Tighten torque for the M6 bolts is 10 Nm

Thruster fitment

1. Make sure the thruster rod is extended i.e. it is not pressurised.
2. Take hold of the thruster and turn the push rod via the hex portion clockwise until it stops rotating; so a 'clicking' can be heard from the ratchet. **Do this by hand, do not apply heavy force to push the rod once it stops turning.**
3. Offer thruster to caliper making sure that both lock nuts are removed before placing hex section of push rod through caliper arm.
4. Pull caliper arms apart so that the pads are hard against the disc.
5. Fit lock nuts to thruster body loosely and unwind push rod until the gap between the body and the arm is 6mm. Make sure that the hex section of the push rod is within the slot of the other arm.
6. Tighten first lock nut to 50 - 60Nm then tighten the second nut against the first.
7. Fit tension spring to arms.

